

FYH UCFCX12-39 Bearing units

Bearing No. UCFCX12-39

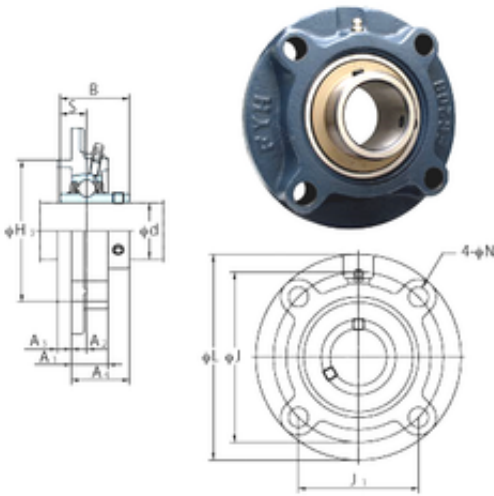

UCFCX12-39 Bearing 2D drawings and 3D CAD models

Bore Diameter	61,9125 mm
d	61,9125 mm
H3	140 mm
A4	50,7 mm
A1	33 mm
B	65,1 mm
J	165 mm
L	194 mm
N	16 mm
S	25,4 mm
Bolt (G)	M14
A2	11 mm
A3	20 mm
J1	116,7 mm
Weight	5,3 Kg
Basic dynamic load rating (C)	57,2 kN
Basic static load rating (C0)	40,1 kN